



# User Manual

## XG3-10KTL Grid-tied Solar Inverter



INVT Solar Technology (Shenzhen) Co., Ltd.

## **Preface**

The manual is intended to provide detailed information of product, installation, application, trouble shooting, precautions and maintenance of iMars series grid-tied solar inverter. The manual does not contain all the information of photovoltaic system. Please read this manual carefully and follow all safety precautions seriously before any moving, installation, operation and maintenance to ensure correct use and high performance of operation on the inverter.

The use of the iMars series grid-tied solar inverters must comply with local laws and regulations on grid-tied power generation.

The manual needs to be kept well and be available at all times.

All rights reserved. The contents in this document are subject to change without notice.

There might be some deviations on actual inverter and data due to product updating, please refer to the actual product.

# Contents

<b>Preface</b> .....	<b>i</b>
<b>Contents</b> .....	<b>ii</b>
<b>1. Safety precautions</b> .....	<b>1</b>
1.1 Warning marks .....	1
1.2 Safety guidance .....	2
1.2.1 Transport and installation .....	3
1.2.2 Grid-connected operation .....	3
1.2.3 Maintenance and inspection .....	4
1.2.4 Waste disposal .....	4
<b>2 Product overview</b> .....	<b>5</b>
2.1 PV grid-connected power generation system .....	5
2.2 Product appearance .....	6
2.3 Nameplate description .....	7
2.4 Product model .....	8
2.5 Outline dimension and weight .....	9
2.6 The LED light panel .....	10
2.6.1 The LED light panel .....	10
2.6.2 LCD operation panel .....	11
2.7 Bottom of the inverter .....	12
<b>3 Inverter storage</b> .....	<b>13</b>
<b>4 Installation</b> .....	<b>14</b>
4.1 Unpacking confirmation .....	14
4.2 Prepare before installation .....	16
4.2.1 Installation tool .....	16
4.2.2 Installation environment .....	16
4.3 Space requirements .....	17
4.4 Mounting board size .....	18
4.5 Wall installation .....	19
4.6 Install the inverter .....	19
<b>5 Electrical connection</b> .....	<b>21</b>
5.1 Overview of electrical connections .....	21

---

5.2 Connect the protective ground wire .....	21
5.3 Connection of PV string .....	22
5.4 Connection of DRM & CT .....	24
5.5 Single-phase inverter grid access .....	25
<b>6 Running .....</b>	<b>26</b>
6.1 Inspection before running .....	26
6.2 Inverter grid-connected running .....	26
6.3 Inverter stop .....	27
6.4 Daily maintenance and inspection .....	27
6.4.1 Periodic maintenance on the inverter .....	27
6.4.2 Maintenance guidance .....	28
<b>7 Troubleshooting .....</b>	<b>30</b>
<b>8 Contact information .....</b>	<b>34</b>
<b>9 Appendix .....</b>	<b>35</b>

## 1. Safety precautions

iMars series grid-tied solar inverters are designed and tested strictly in accordance with relevant international safety standards. As an electrical and electronic device, all relevant safety regulations must be strictly complied during installation, operation, and maintenance. Incorrect use or misuse may result in:









- Injury to the life and personal safety of the operator or other people.
- Damage to the inverter or other property belonging to the operator or other people.

In order to avoid personal injury, damage to the inverter or other devices, please strictly observe the following safety precautions.







This chapter mainly describes various warning symbols in operation manual and provides safety instructions for the installation, operation, maintenance and use of the iMars series grid-tied solar inverters.

### 1.1 Warning marks

Warning marks is alerting users to conditions which may cause serious physical injury or death, or damage to the device. They also tell users how to prevent the dangers. The warning marks used in this operation manual are shown below:

Mark	Name	Instruction	Abbreviation
 Danger	Danger	Serious physical injury or even death may occur if not follow relevant requirements.	
 Warning	Warning	Physical injury or damage to the device may occur if not follow relevant requirements.	
 Forbid	Electrostatic sensitive	Damage may occur if relevant requirements are not followed.	
 Hot	High temperature	Do not touch the base of the inverter as it will become hot.	
<b>Note</b>	Note	The procedures taken for ensuring proper operation.	<b>Note</b>

## 1.2 Safety guidance

	<ul style="list-style-type: none"> <li>● After receiving this product, first please confirm the product package is intact. If any question, please contact the logistic company or local distributor immediately.</li> <li>● The installation and operation of PV inverter must be carried out by professional technicians who have received professional training and thoroughly familiar with all the contents in this manual and the safety requirements of the electrical system.</li> <li>● Do not carry out cable connection/disconnection, cover open for inspection and unit replacement operations on the inverter when power is connected. Before wiring and inspection, users must confirm the breakers on DC and AC side are disconnected and wait for at least 5 minutes.</li> </ul>
	<ul style="list-style-type: none"> <li>● Ensure there is no strong electromagnetic interference caused by other electronic or electrical devices around the installation site.</li> <li>● Do not refit the inverter unless authorized.</li> <li>● All the electrical installation must conform to local and national electrical standards.</li> </ul>
	<ul style="list-style-type: none"> <li>● Do not touch the housing of the inverter or the radiator to avoid scald as they may become hot during operation</li> </ul>
	<ul style="list-style-type: none"> <li>● Must be reliably grounded before operation.</li> </ul>
	<ul style="list-style-type: none"> <li>● Do not open the surface cover of the inverter unless authorized. The electronic components inside the inverter are electrostatic sensitive. Do take proper anti-electrostatic measures during authorized operation.</li> </ul>
	<ul style="list-style-type: none"> <li>● Grounding mark. The inverter must be reliably grounded.</li> </ul>
	<ul style="list-style-type: none"> <li>● Discharging mark. Ensure that DC and AC side circuit breakers have been disconnected and wait at least 5 minutes before wiring and checking.</li> </ul>
<p><b>Note:</b> Technical personnel who can perform installation, wiring, commissioning, maintenance, troubleshooting and replacement of the iMars series grid-tied solar inverters must meet the following requirements:</p>	
<ul style="list-style-type: none"> <li>● Operators need professional training.</li> <li>● Operators must read this manual completely and master the related safety precautions.</li> <li>● Operators need to be familiar with the relevant safety regulations for electrical systems.</li> </ul>	

- Operators need to be fully familiar with the composition and operating principle of the entire grid-tied photovoltaic power generation system and related standards of the countries/regions in which the project is located.
- Operators must wear personal protective equipment.

### 1.2.1 Transport and installation

	<ul style="list-style-type: none"> <li>● During storage or transport, ensure the inverter package and the chassis is intact, dry and clean.</li> <li>● The movement and installation of the inverter require at least two persons due to its heavy weight.</li> <li>● Select proper tools for movement and installation to ensure the inverter can operate normally and avoid physical injury. The installation personnel must take mechanical protective measures such as wearing anti-drop shoes or working clothes to protect physical security.</li> <li>● The inverter must be installed by professional technicians.</li> <li>● Do not store or install the inverter on or close to flammable and explosive objects;</li> <li>● Do not install the inverter in the place where children and other public can easily touch</li> <li>● Remove the metal accessories in hands eg ring or bracelet before device installation and electrical connection to avoid electric shock.</li> <li>● The solar cell module exposed to the sunlight may generate dangerous voltage. Users must cover the solar cell with fully-lightproof materials before electrical connection</li> <li>● The inverter input voltage cannot exceed the max input voltage, otherwise the inverter may be damaged.</li> <li>● PV grid-connected inverter is not applicable to the positive or negative ground system of solar cell panel.</li> <li>● Ensure inverter PE is grounded properly, otherwise the inverter cannot run normally.</li> <li>● Ensure the inverter is installed firmly and electrical wiring is reliable.</li> </ul>
---	--

**Note:** PV grid-connected inverter is only suitable for crystalline silicon-type solar battery component.

### 1.2.2 Grid-connected operation

	<ul style="list-style-type: none"> <li>● Permissions by local electric power agency must be obtained and the inverter grid-connected power generation operation must be done by professional technicians.</li> <li>● All electrical connections must meet the electrical standards of the</li> </ul>
---	--

	<p>countries/regions in which the project is located.</p> <ul style="list-style-type: none"> <li>● Ensure the inverter is installed firmly and electrical wiring is reliable before operating on the inverter.</li> <li>● Do not open the inverter when it is running or connecting power</li> </ul>
--	--

### 1.2.3 Maintenance and inspection

	<ul style="list-style-type: none"> <li>● The maintenance, inspection and repair of the inverter must be done by well trained and qualified professional technicians.</li> <li>● Contact distributor or manufacture for inverter repairing.</li> <li>● In order to avoid irrelevant personnel entering the maintenance area during maintenance, temporary warning labels must be placed to warn non-professionals to enter or please isolate with fences.</li> <li>● Before carrying out any maintenance operations, users must disconnect the breaker on grid side, then disconnect the breaker connected to the PV module and wait-at least 5 minutes until the internal parts of the inverter are fully discharged.</li> <li>● The internal of inverter are mostly electrostatic-sensitive circuits and parts, users must follow electrostatic protection rules and take anti-electrostatic measures.</li> <li>● Do not use components provided by other companies when repairing the inverter.</li> <li>● The inverter can be started again for grid-connected power generation only after confirming there is no fault that may impact the safety performance of the inverter.</li> <li>● Do not get close to or touch the grid or any metal conductive parts in the PV power generation system during operation, otherwise electric shock or fire may occur. Take note of any safety marks and instructions such as "Danger, electric shock risk".</li> </ul>
---	--

### 1.2.4 Waste disposal

	<ul style="list-style-type: none"> <li>● Do not dispose of the inverter together with household waste. The user has the responsibility and obligation to send it to the designated organization for recycling and disposal.</li> </ul>
---	--



## 2 Product overview

This chapter mainly introduces the appearance, package accessories, nameplate, technical parameters of the grid-connected inverter.

### 2.1 PV grid-connected power generation system

PV grid-connected power generation system is comprised of solar battery component, grid-connected inverter and public grid.

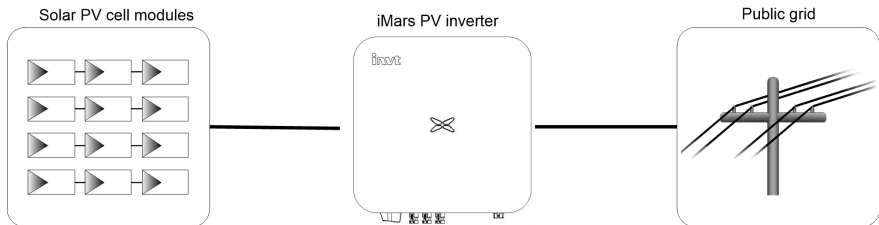

Fig 2.1 Application of PV grid-connected inverter

The PV grid-connected inverter is the core part of solar PV grid-connected power generation system. The sunlight can be converted through PV panel to DC power, which further converted by grid-tied inverter to the sine AC current with the same frequency and phase position as the public grid, then feedback the AC power to the grid.

The PV grid-tied inverter is only for the solar PV power generation grid-tied system, and only uses the Crystalline Silicon Solar Cells whose positive and negative electrodes are not grounded as the DC input.



- It is recommended that the PV array to be installed conforms to IEC 61730 class A standards.

## 2.2 Product appearance

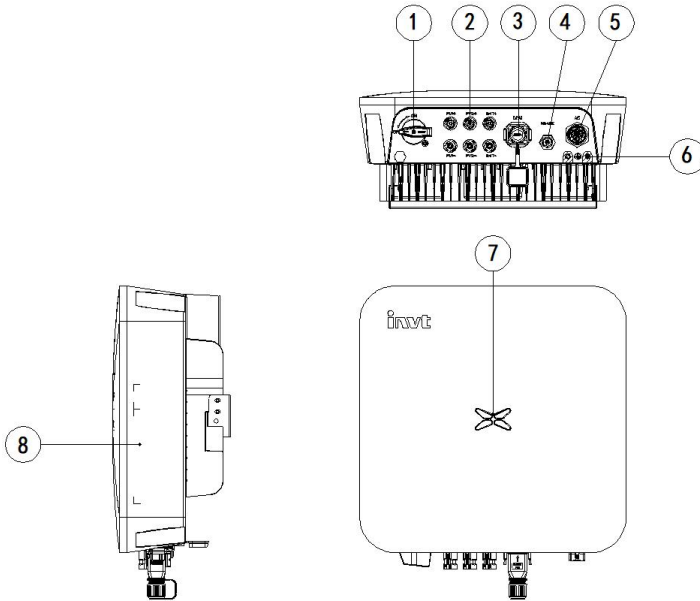

Figure 2.3 Appearance of the single-phase PV inverter

Table 2-1 Description of key exterior components of single-phase PV inverters

Number	Name	Introduction
1	DC switch	Close/disconnect the PV array
2	DC input interface	Inverter DC input terminal, connected to the PV array
3	Communication interface	CT,DRM interface
4	RS485-1	485 communication interface
5	AC terminal	Inverter AC output port, connect to public grid
6	Ground terminal	There are two in total, choose at least one of them to connect
7	LED pilot lamp	Instructions inverter current working condition
8	Nameplate	Mark the inverter rating parameter

## 2.3 Nameplate description

Figure 2.4 shows the inverter nameplate.





<b>invt</b>		Grid-tied Solar Inverter
<b>iMars XG8KTL</b>		
DC Input		
Vmax. PV	600V	
MPPT Range	80V-560V	
Max. Current	20A/20A	
Isc PV	26A/26A	
AC Output		
Nominal Voltage	230Vac	
Max. Current	40A	
Rated Power	8000W	
Max. Output Power	8800VA	
Frequency	50Hz/60Hz	
Power factor range	0.80un ~ 0.80ov	
Environment		
Temperature	-30°C ~ +60°C	
Protective Class	I	
Inverter topology	Non-isolated	
Ingress protection	IP66	
		
<div style="border: 1px dashed black; width: 150px; height: 40px; margin: 0 auto;"></div> <p>Made in China</p>		
<b>INVT Solar Technology (Shenzhen) Co.,Ltd.</b>		

Figure 2.4 Nameplate

- (1) Trademarks and product types
- (2) Model and important technical parameters
- (3) Certification system of the inverter confirming, serial number, company name and country of origin

Icons	Instruction
	<ul style="list-style-type: none"> <li>● TUV certification mark. The inverter is certified by TUV</li> </ul>
	<ul style="list-style-type: none"> <li>● CE certification mark. The inverter complies with the CE directive</li> </ul>
	<ul style="list-style-type: none"> <li>● CQC certification mark. The inverter passed CQC certification</li> </ul>
	<ul style="list-style-type: none"> <li>● EU WEEE mark. The inverter cannot be disposed of as domestic waste</li> </ul>

## 2.4 Product model

Table 2-2 Models of single-phase PV grid-connected inverters

Product name	Model	Rated output power (W)
<b>Single-phase (L、N、 PE)</b>		
Single-phase PV grid-connected inverter	XG3KTL-2M	3000
Single -phase PV grid-connected inverter	XG4KTL	4000
Single -phase PV grid-connected inverter	XG5KTL	5000
Single -phase PV grid-connected inverter	XG6KTL	6000
Single -phase PV grid-connected inverter	XG7KTL	7000
Single -phase PV grid-connected inverter	XG8KTL	8000
Single -phase PV grid-connected inverter	XG10KTL	10000
Single -phase PV grid-connected inverter	XG7KTL1	7000
Single -phase PV grid-connected inverter	XG8KTL1	8000
Single -phase PV grid-connected inverter	XG10KTL1	10000

Note: Technical parameters of PV grid-connected inverter refer to the appendix.

## 2.5 Outline dimension and weight

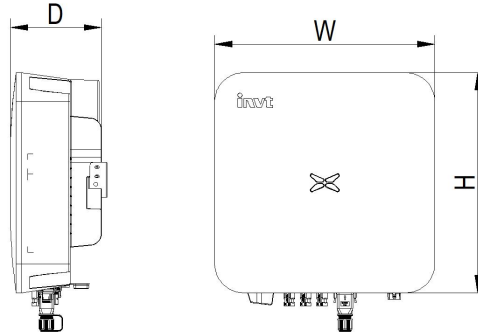

Figure 2.5 Outline dimensions of the inverter

Table 2-3 Dimensions and net weight of the inverter

Model	Height(mm)	Width(mm)	Depth(mm)	Net weight(kg)
XG5KTL	380	380	160	12
XG8KTL	380	380	160	12.6
XG10KTL	380	380	160	13.0

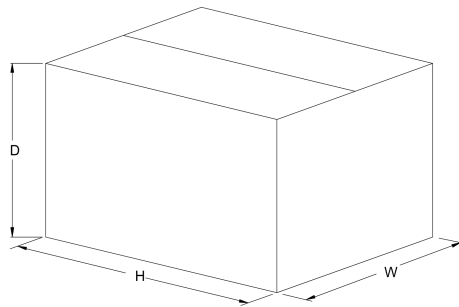

Fig 2.6 Dimension of paper package

Table 2-4 Dimension and gross weight

Model	Height (mm)	Width (mm)	Depth (mm)	Weight (kg)	Package material
XG5KTL	465	485	270	14.0	Corrugated case
XG8KTL	465	485	270	14.6	Corrugated case
XG10KTL	465	485	270	15.0	Corrugated case

## 2.6 The LED light panel

The LED indicator panel as the human-computer interaction interface, may indicate the working state of the inverter.

### 2.6.1 The LED light panel

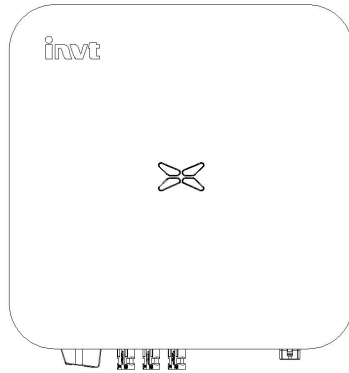
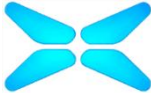



Figure 2.7 LED Front View

LED indicator status description:

	Steady blue	Normal, grid-tied and generating power
	Blinking blue at short interval (0.2s)	Bluetooth connected and with communication. And inverter has no error
	Blinking blue at long interval (2s)	DC or AC connected, inverter in standby or starting (no power generation)
	Steady red	Error occurs.( The inverter fail to connect to the grid)
	Blinking red	Bluetooth connected and in communicating but inverter has error
	Red light off	AC and DC have been powered off.

2.6.2 LCD operation panel

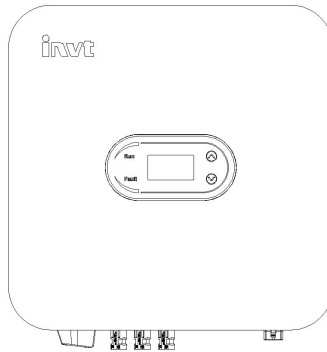

Figure 2.8 LCD Front View

Definition of LCD operation panel:

① "Run", running status, shows green light;	
② "Fault", the PV string is disconnected, shows red light;	
③ Select upwards, short press to move upwards, long press to return;	
④ Select downward, short press to move down, long press to confirm.	

LED light display status description:

Indicator light	Instruction	State	Description
Run	Grid-connected indicator light	Green light on	connected to grid
		Green light off	Not connected to grid
		Green light flashes (0.5s On, 0.5s Off)	The inverter is in maintenance status
Fault	The PV connection indicator light	Red light on	The power-on indicator light, it indicates that at least one of the PV strings is connected normally and the input voltage is $\geq 150V$
		Red light off	The inverter is disconnected from all PV strings, or the DC input voltage of all MPPT circuits is less than 150V

## 2.7 Bottom of the inverter

XG3-10KTL is equipped with a DC switch that controls the DC terminal switch.

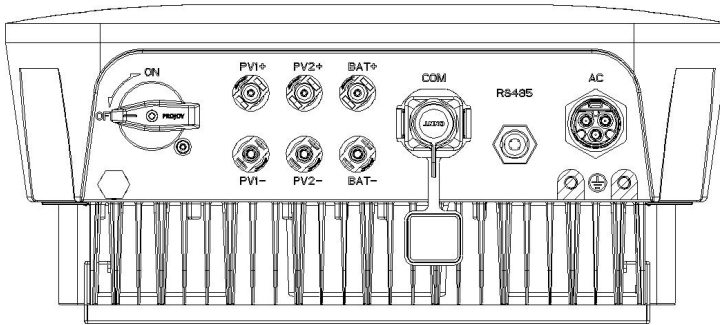

Figure 2.9 without fan

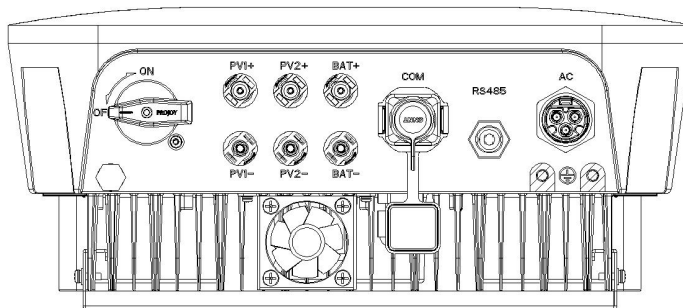

Figure 2.10 with fan(XG7KTL1, XG8KTL1, XG10KTL, XG10KTL1)



### 3 Inverter storage

If the inverter is not put into use immediately, the storage of inverter should meet the following requirements:

- Do not remove the inverter outer package.
- The inverter needs to be stored in a clean and dry place, and to prevent the erosion of dust and moisture.
- The storage temperature should be kept at  $-30^{\circ}\text{C}\sim+70^{\circ}\text{C}$ , and the relative humidity should be kept at 0%RH~100f%RH.
- If multiple inverters to be stacked, it is recommended to place them according to the original stacking layer number at the time of delivery. When stacking, please place the inverter carefully to avoid personal injury or equipment damage caused by equipment tipping.
- Avoid chemical corrosive substances, otherwise it may corrode the inverter.
- During storage, regular inspections are required. If insect bites or packaging damage are found, the packaging materials must be replaced in time. After long-term storage, the inverter needs to be inspected and tested by professionals before it can be put into use.

## 4 Installation

This chapter introduces the installation of the inverter and the connection of the inverter to the PV power generation system. Connecting inverters to PV power generation systems mainly involves the PV strings and public grids connect to the inverter.

Please read this chapter carefully before installation, and ensure that all installation conditions are met by professional technicians to complete the inverter installation.

### 4.1 Unpacking confirmation

The inverter has been thoroughly tested and rigorously checked before delivery, but damage may still occur during transportation. Before unpacking, check carefully whether the product information in the order is consistent with that on the nameplate of the package box and whether the product package is intact. If any damage is detected, please contact the shipping company or the supplier directly. Please also provide photos of the damage to get our fastest and best service.

When the inverter is left unused, please put it in the original packing box and take measures to prevent moisture and dust.

Take out the inverter after unpacking, please check the following items:

- (1) Confirm that the inverter is complete and not damaged;
- (2) Confirm that there are manuals, interface accessories and installation accessories in the packing box;
- (3) Confirm that there is no damage or shortage in the delivery content in the packing box;
- (4) Check whether the order is consistent with the product information on the nameplate of the inverter;
- (5) The standard delivery list is as follows.

Standard deliverables of single-phase inverter:

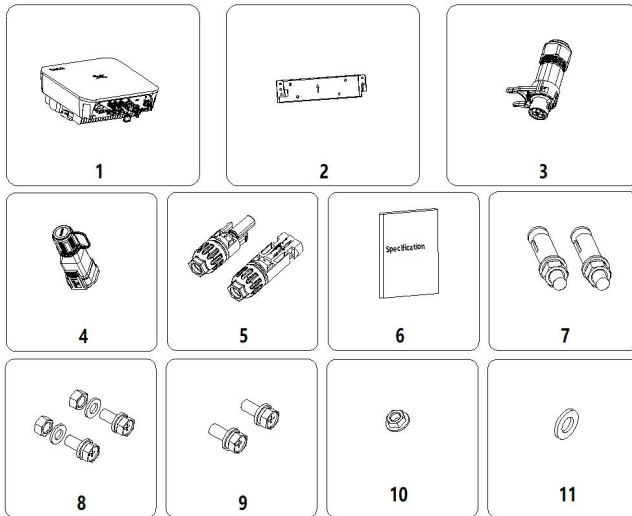

Fig4.1 Delivery content of single-phase inverter 3-10kW

Table 4-1 delivery contents of three-phase inverter

Number	Name	Quantity
1	Inverter	1
2	Mounting bracket	1
3	AC side quick connect terminal	1
4	CT,DRM Connect the terminals	1
5	DC connector (pair)	2
6	User manual	1
7	Stainless Steel Expansion Bolts M6*50	4
8	M6 combination bolt	4
9	M4combination bolt	4
10	M6 nut	4
11	M6 Flat Washer	4

Please check the above carefully. If you have any questions, please contact the supplier in time.

## 4.2 Prepare before installation

### 4.2.1 Installation tool

Table 4-2 List of installation tools

Number	Installation tools	instruction
1	Marker pen	Mark the mounting holes
2	Electric drill	Drill holes in the bracket or wall
3	Hand hammer	Knock the expansion bolt
4	Adjustable wrench	For fixed mounting bracket
5	"Flat" or "Cross" screwdriver	For AC wiring
6	Meg ohmmeter	Measure insulation performance and impedance to ground
7	Multi-meter	Detect circuit and measure AC and DC voltage
8	Electric soldering iron	Welding communication cable
9	Crimping Tool	Crimp DC terminal
10	Hydraulic clamp	Crimp ring terminal for AC wiring

### 4.2.2 Installation environment

- (1) The inverter can be installed in indoor and outdoor environment.
- (2) During the operation of the inverter, the temperature of the chassis and heat sink will be relatively high. Please do not install the inverter in the easily touched position.
- (3) Do not install inverters in areas where flammable and explosive materials are stored.
- (4) The inverter shall be installed in a well-ventilated environment to ensure inverter heat dissipation.
- (5) It is recommended to choose the installation site with shelter or build

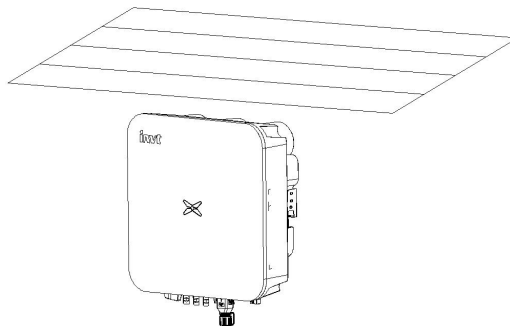

Fig 4.2 Sunshade

- (6) The installation environment temperature is  $-30\text{ }^{\circ}\text{C} \sim 60\text{ }^{\circ}\text{C}$ ;
- (7) The installation site should be far away from the electronic equipment with strong electromagnetic interference;
- (8) The installation site should be fixed and solid object surface, such as wall, metal support, etc;
- (9) The installation position shall ensure the reliable grounding of the inverter, and the grounding metal conductor material shall be consistent with the reserved grounding metal material of the inverter.

### 4.3 Space requirements

- (1) The height of installation position shall ensure that the line of sight and LED display light are on the same horizontal plane, so as to check the inverter status conveniently .

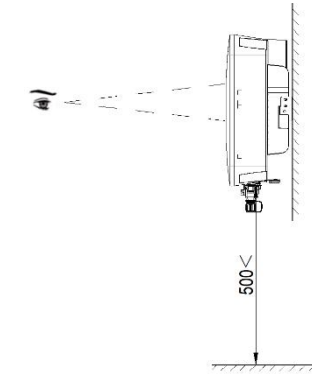

Fig4.3 Optimum installation height area

- (2) There is enough reserved space around the installation site to facilitate the disassembly and assembly of inverter and air convection. As shown in Fig 4.3.

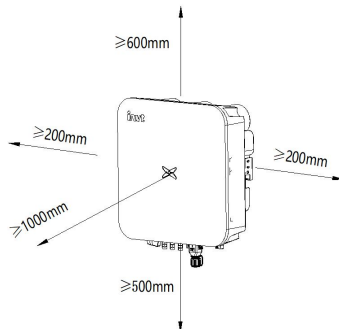

Fig 4.4 Installation spacing of inverter

(3) When installing multiple inverters, a certain distance shall be reserved between the inverters, as shown in Figure 4.4. At the same time, sufficient distance shall be reserved between the upper and lower parts of the inverter to ensure good heat dissipation .

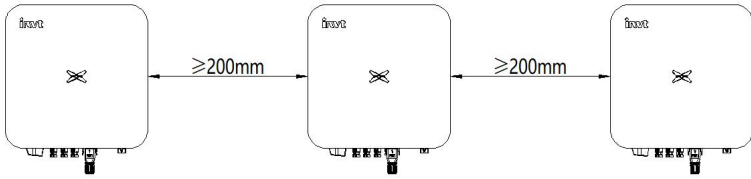

Fig 4.5 Size requirements for side-by-side installation

(4) The installation surface should be perpendicular to the horizontal line, as shown in Figure 4.5. Please install the inverter vertically or backward  $\leq 15^\circ$  to facilitate the heat dissipation of the machine. Do not tilt the inverter forward, horizontally, upside down, leaning too far, or tilting to the side.

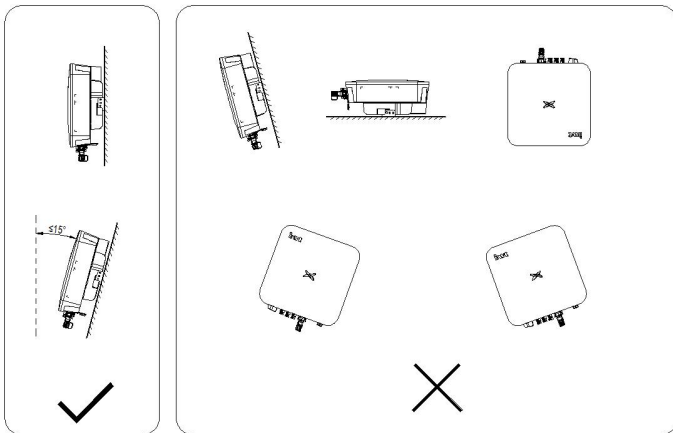

Fig 4.6 Installation position of inverter

#### 4.4 Mounting board size

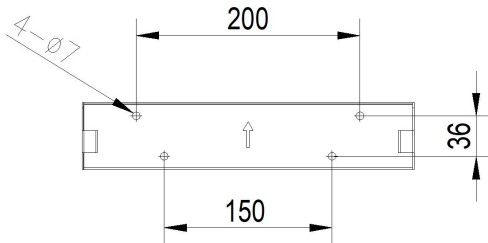
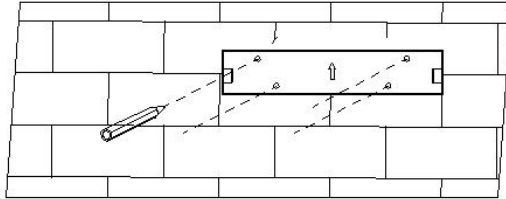

Fig 4.7 Dimensions of the mounting plate

## 4.5 Wall installation

**Step 1:** Place the hanging board on the wall mounting point, use a level to adjust the angle, and mark with a marker.



**Step 2:** Use a hammer drill to drill holes and install expansion bolts. Use M6×50 stainless steel pressure explosion expansion bolts.

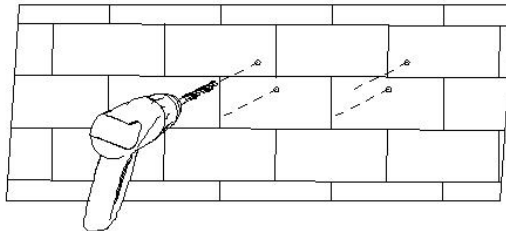

**Step 3:** Fix the hanging board. Clean the holes, use a rubber hammer to drive the expansion bolt into the hole, use a wrench to tighten the nut to fix the end of the bolt, then remove the nut, spring washer and flat washer, and then fix the wall mount plate to the wall and lock it with a tightening torque of 13N\*m. .

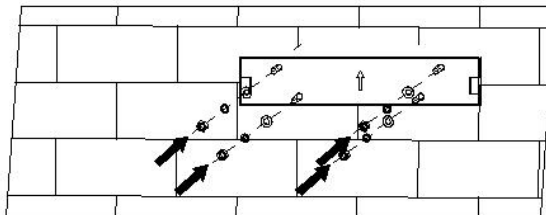

## 4.6 Install the inverter

**Step 1:** Take the inverter out of the packaging box.

**Step 2:** If the installation location is high, you need to lift the inverter to the hanging plate, use the lifting equipment to lift the inverter 100mm off the ground and then pause, check the tightness of the

hoisting ring and rope. After confirming that the connection is secure, lift the inverter to the destination.

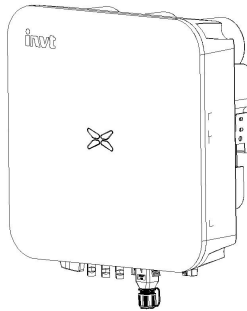

**Step 3:** After lifting the inverter, buckle the bracket plate on the back of the machine into the wall-mounting plate, and make sure that the machine bracket plate fits well with the groove of the hanging plate.

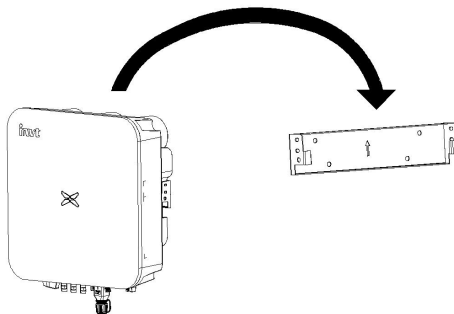

**Step 4:** After the inverter is stably hung on the wall mount, fix the M4 screws on the left and right of the chassis.

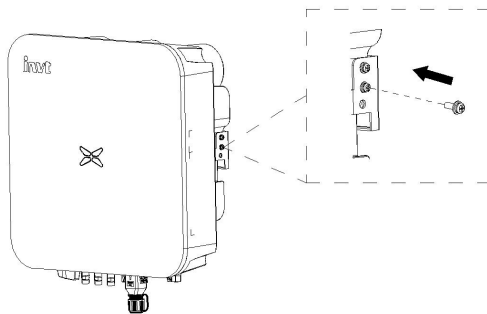



## 5 Electrical connection

### 5.1 Overview of electrical connections

This section will introduce the electrical connection related content and related safety precautions in detail.

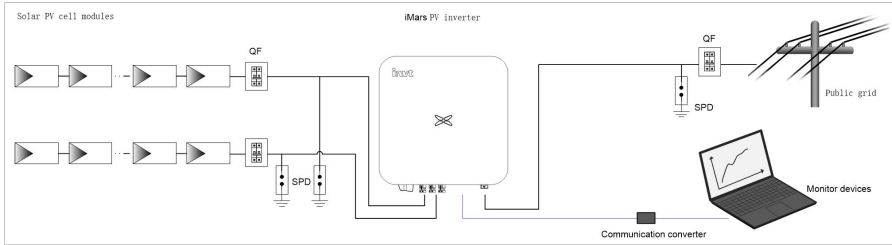

Fig 5.1 Schematic diagram of PV grid-connected system connection

	<ul style="list-style-type: none"> <li>● Electrical connections must be completed by professional worker. Wrong operation may cause equipment damage during system operation, and even personal injury.</li> <li>● All electrical installations must comply with national/regional electrical safety regulations.</li> <li>● Ensure that all cables are installed tightly, without any damage, and meet the specified safety requirements.</li> <li>● It is not allowed to turn on the AC and DC circuit breakers before the inverter completes the electrical connection and check.</li> </ul>
<b>Note</b>	<ul style="list-style-type: none"> <li>● Read this section carefully and operate strictly according to the requirements.</li> <li>● Pay attention to the rated voltage and current values specified in this manual, and do not exceed the limit values specified in this manual.</li> </ul>

### 5.2 Connect the protective ground wire

**Step 1:** Crimp the OT terminal to the ground wire

**Step 2:** Remove the screws in the ground position on the bottom of the chassis, fix the ground wire with the screw and tighten the tightening torque 7-9N•m.

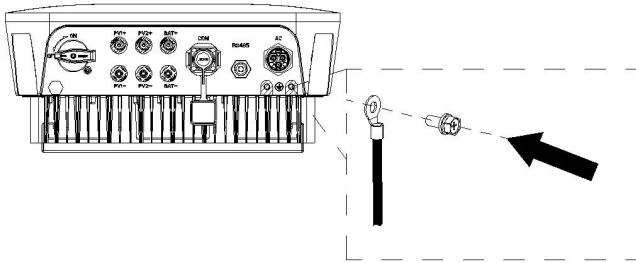



Fig 5.2 PV grounding diagram

	<ul style="list-style-type: none"> <li>● The inverter must be grounded through the side screws to ensure reliable grounding and reliable lightning protection.</li> </ul>
---	---

### 5.3 Connection of PV string

**Step 1:** Connect the outlet line of the PV panel to the MC4 terminal delivered by the machine

The MC4 terminal crimping method is as follows:

(1) As shown in Fig 5.2, connect the output wire of the PV string to the DC connector of the inverter. Loosen the fastening nut of the connector; strip off the 15mm insulation layer of the DC cable, and use crimping pliers to press the standard metal terminal tightly. The tightening torque of the waterproof part of the tail is 2.5-3Nm. The wiring method of the positive and negative connectors is the same. Confirm that the positive and negative poles of the PV string correspond correctly to the positive and negative connectors ,then connect them firmly;

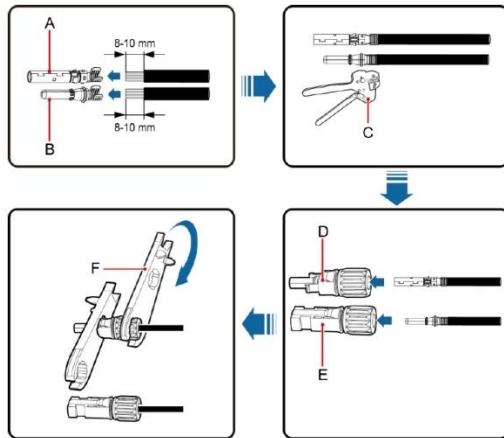

Fig 5.3 Connection between MC4 DC connector and PV string

(2) After the DC connector is connected, use a multi-meter to measure the voltage of the DC input

string, verify the polarity of the DC input cable, and ensure that the voltage of each string is within the allowable range of the inverter, as shown in Fig 5.3.

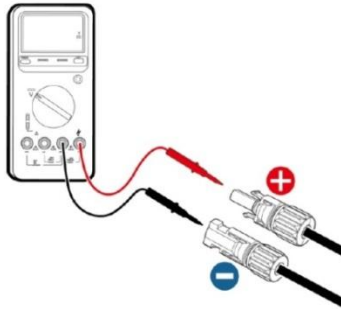



Fig 5.4 Measuring DC input voltage

	<ul style="list-style-type: none"> <li>● The PV string connected to iMars series inverter must adopt the DC connector configured especially for the inverter, do not use other connection devices without authorization from our company, otherwise damage to the device, unstable operation or fire may occur and our company will not undertake quality assurance or assume</li> </ul>
---	--

**Step 2:** After the DC terminal is connected, it is directly connected to the MC4 terminal of the inverter.

(1) Connect the positive and negative connectors of the PV strings that have been connected to the corresponding positions of the inverter DC interface, and confirm the tight connection, as shown in Fig 5.5;

(2) When disassembling the DC connector from the inverter, insert the tip of a slotted screwdriver into the raised hole in the middle of the connector, and force the movable end of the connector to withdraw.

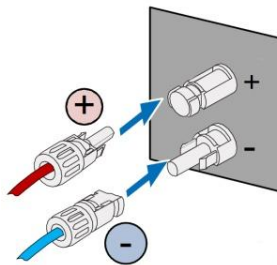

Fig 5.5 PV DC string connected to the inverter

### 5.4 Connection of DRM & CT

The picture of DRM & CT connector is as follows:

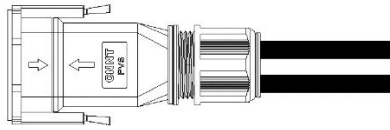

Fig 5.6 DRM & CT connector side view

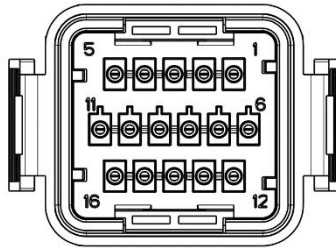



Fig 5.7 DRM & CT connector Front view

Table 5-1 The DRM & CT connector Signal description

Pin NO.	Name	Signal name
1	485L-1	485L-1
2	485H-1	485H-1
3	485L-2	485L-2
4	485H-2	485H-2
5	External CT input positive	CT+
6	External CT input negative pole	CT-
7	+5V	+5V
8	COM/DRM0	COM/DRM0

## 5.5 Single-phase inverter grid access

Table 5-2 Single-phase photovoltaic inverter AC connector interface description

Inverter AC connector interface	Single-phase grid	Remarks
L	live wire	
N	neutral line	
	PE ground wire	Must be connected

### 5.5.1 Connection terminal grid access

(1) According to Table 5-1, the three conductors of single-phase public power grid L, N and PE are correctly connected to the corresponding holes according to the identification, and ensure that the conductors are not exposed and crimped firmly, and finally tighten the waterproof cap, as shown in Fig 5.8;

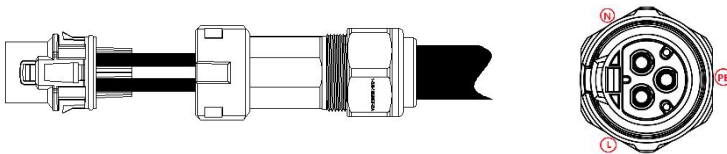

Fig 5.8 Crimp cable terminal

(2) Connect the AC quick connect terminal to the inverter.

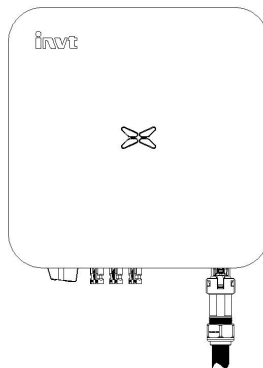

Fig 5.9 Single-phase inverter grid connection

### 5.5.2 Grid voltage requirements

Before installing the PV inverter, you need to confirm the working voltage of the AC side of the product.

## 6 Running

This chapter introduces the related operations during the use of the inverter, which mainly involves pre-operation inspections, grid-connected operation of the inverter, inverter shutdown, and precautions for daily maintenance and repair of the inverter.

### 6.1 Inspection before running

The following items must be checked strictly before running the PV grid-connected inverter (including but not limited to the following items):

- (1) Confirm the installation site of the inverter meet requirements of section 4.2.2 to ensure convenient installation, disassemble, operation and inspection on the inverter;
- (2) Confirm the mechanical installation of the inverter meet requirements of section 5.3;
- (3) Confirm the electrical connection of the inverter meet the requirements of section 4.4;
- (4) Confirm all the switches are in "OFF" state;
- (5) Confirm the open-circuit voltage of PV module conforms to the parameter requirements of inverter DC side in appendix;
- (6) Confirm the electrical safety marks on the installation site is clear enough.



- In order to ensure a safe, normal and stable operation of the PV power generation system, all the newly installed, renovated and repaired PV grid-connected power generation system and its grid-connected inverter must undergo inspection before running.

### 6.2 Inverter grid-connected running

Please strictly follow the steps below to turn on the inverter and complete the grid-connected operation of the inverter:

#### Note

- For the first operation of the inverter, a country must be selected to set grid-connected standards.
- Please keep the inverter powered on for at least 30 minutes, and complete the charging of the built-in clock battery of the inverter to ensure the normal operation of the clock!

- (1) Make sure that the inspection items in Section 6.1 meet the requirements;
- (2) Turn on the AC side circuit breaker of the inverter public grid;
- (3) Turn on the DC switch integrated in the inverter;
- (4) Turn on the switch on the DC input side of the photovoltaic string;
- (5) Observe the status of the inverter's LED lights or the information displayed on the LCD screen (refer to section 2.6 for LED status lights and LCD display information);

(6) Wait for the inverter to connect to the grid successfully.

## 6.3 Inverter stop

When it is necessary to perform power failure maintenance, overhaul, and troubleshooting of the inverter, please strictly follows the steps below to shut down the inverter:

- (1) Disconnect the AC side circuit breaker of the inverter public grid;
- (2) Disconnect the DC switch integrated in the inverter;
- (3) Disconnect the line switch on the DC input side of the photovoltaic string;
- (4) Wait at least 3 minutes until the internal components of the inverter are discharged, and the inverter shutdown operation is completed.

## 6.4 Daily maintenance and inspection

In the PV grid-connected system, even if the day and night change and the season changes, the PV grid-connected inverter can automatically complete grid-connected power generation, shutdown and start-up operations without human control. In order to ensure and prolong the service life of the inverter, in addition to using the inverter in strict accordance with the content specified in this manual, it is also necessary to carry out the necessary daily maintenance and inspection of the inverter.

### 6.4.1 Periodic maintenance on the inverter

Check Item	Inspection Method	Maintenance Cycle
Save inverter operating data	The monitoring software is used to read the data of the inverter in real time, and the data recorded by the monitoring software is regularly backed up. Save the inverter's operating data, parameters and logs recorded in the monitoring software to a file. Check the monitoring software and check the inverter parameter settings through the handheld keyboard.	Once per quarter
Inverter running status	Observe whether the inverter is installed firmly and whether it is damaged or deformed. To listen whether there's any abnormal sound during inverter running. When the system is connected to the grid, check various variables. Check whether the heating of the inverter shell is normal, and use a thermal imager to monitor the heating of the system.	Once per half a year
Clean the inverter	Check the RH and dust around the inverter, and clean the inverter when necessary. Refer to section 6.4.2.	Once per half a year

Check Item	Inspection Method	Maintenance Cycle
Electrical connections	Check whether the system cable connection is loose, whether the inverter wiring terminal is loose, and then tighten it according to the method specified in section 4. Check whether the cable is damaged, especially whether the rubber skin in contact with the metal surface has cut marks.	Once per half a year
Cooling fan maintenance and replacement	For three-phase inverter products, observe whether the air inlet and outlet are normal, and check whether there are cracks in the fan blades. Listen for abnormal vibration when the fan is running. If necessary, clean the air inlet and outlet; if the fan is abnormal, it needs to be replaced in time, see section 6.4.2.	Once per half a year
Security function	Check the inverter LCD and the shutdown function of the system. Simulate stop and check the stop signal communication. Check the warning labels and replace them if necessary.	Once per half a year

**6.4.2 Maintenance guidance**

**Inverter cleaning**

The cleaning steps are as follows:

- (1) Disconnect the input and output connections.
- (2) Wait ten minutes.
- (3) Use a soft brush or vacuum cleaner to clean the surface of the inverter and the air inlet and outlet.
- (4) Repeat the operation content in section 6.1.
- (5) Restart the inverter.

**Fan maintenance**

	<ul style="list-style-type: none"> <li>● Stop the inverter before maintenance work, and all power inputs of the inverter must be disconnected.</li> <li>● Wait at least 3 minutes for the capacitors inside the inverter to fully discharge before starting maintenance work.</li> <li>● Only professional electricians can perform maintenance and replacement of the fan.</li> </ul>
---	--



**Step 1:** Stop the inverter and disconnect the electrical connection.

- (1) Disconnect the input and output connections.
- (2) Turn the DC switch to the "OFF" position.
- (3) Wait ten minutes.
- (4) Disconnect all electrical connections at the bottom of the inverter.

**Step 2:** Disconnect the fan power plug and remove the fan cover at the bottom of the chassis.

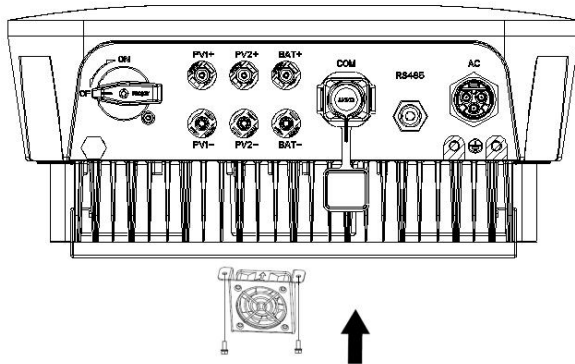

**Step 3:** Use a soft brush or vacuum cleaner to clean the fan. If the fan is damaged, follow step 4.

**Step 4:** If the fan is damaged, remove the damaged fan and install the good fan to its original position.

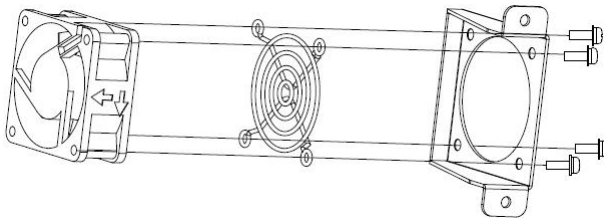

**Step 5:** Re-install the fan tray to the inverter in the reverse order and restart the inverter. .

**Note**

- Once the inverter stops due to an alarm, it is prohibited to start the inverter immediately. You should find out the cause and confirm that all faults have been eliminated before starting the inverter. The inspection should be carried out strictly in accordance with the steps in section 6.1.

## 7 Troubleshooting

This chapter introduces fault alarms and codes, which are used to quickly find inverter faults.

Table 7-1 Inverter fault codes

Number	Fault types	Fault code	Fault information	Solution
1	PV voltage fault	01-01	Low PV voltage	Check whether the PV terminal is plugged in properly
		01-02	High PV voltage	Check whether the panels are connected in series correctly
2	BUS voltage error	03-01	Low BUS voltage	If the inverter does not work normally, please contact customer service
		03-02	High BUS voltage	
		03-03	BUS voltage imbalance	
3	Flow failures	05-01	Inverter hardware flow	If the fault is reported repeatedly, firstly check whether there is capacitive or inductive equipment on the grid side repeatedly cutting into the grid; if not, please contact customer service
		05-02	Inverter software flow	
		05-03	The BOOST hardware flow	
		05-04	The BOOST software flow	
4	Thermal failure	06-01	Inverter over temperature	Check whether the air inlet and outlet are blocked and whether the ambient temperature is too high
		06-02	BOOST over temperature	
		06-03	Heatsink over temperature	
		06-04	Ambient over temperature	Check for obstacles around the inverter
5	Insulation detection fault	07-01	Insulation detection fault	Check whether the panel wiring terminals have entered the water, or are damaged and exposed to the ground
6	Drive fault	08-01	Drive fault	Please contact customer service
7	Communication fault	09-01	DSP1 and ARM SCI fault	Please contact customer service
		09-02	DSP2 and ARM SCI fault	
		09-03	DSP1 SPI fault	

Number	Fault types	Fault code	Fault information	Solution
		09-04	DSP2 SPI fault	
		09-05	DSP1 and MCU SCI fault	
8	Leakage current fault	10-01	The static leakage current is high	Check whether the panel wiring terminals have entered the water, or are damaged and exposed to the ground
		10-02	30mA mutation failure	
		10-03	60mA mutation failure	
		10-04	150mA mutation failure	
9	Relay fault	11-01	Relay open	Please contact customer service
		11-02	Relay short circuit	
10	DC fault	14-01	DCI R phase fault	Please contact customer service
		14-02	DCI S phase fault	
		14-03	T the DCI fault	
11	Consistency failure	19-01	Inconsistent AC voltage detection	Please contact customer service
		19-02	Inconsistent BUS voltage detection	
		19-03	Inconsistent ISO voltage detection	
		19-04	Inconsistent PV voltage detection	
		19-05	GFCI inconsistent	
12	Mains voltage fault	31-01	Low mains voltage	Use a multimeter Check whether the grid voltage at the inverter end is normal
		31-02	Mains voltage high	
13	Mains frequency fault	33-01	Mains frequency is low	Check with a multimeter whether the grid frequency at the inverter end is normal
		33-02	Mains frequency is high	
14	Leakage current self-checking of failure	43-01	Leakage current sensor fault	Please contact customer service
15	Auxiliary power failure	45-01	Auxiliary power off	Please contact customer service

Table 7-2 Inverter warning code

Number	Alarm types	Alarm code	Alarm information	Display information
1	Fan speed is low	01-01	Fan1	Please contact customer service
		01-02	Fan2	
		01-03	Fan3	
		01-04	Fan4	
2	Lightning protector	02-01	Lightning protector	Please contact customer service
3	String current	03-01	String 1	Unplug the faulty string, and check if the positive and negative terminals are reversed with a multimeter.
		03-02	String 2	
		03-03	String 3	
		03-04	String 4	
		03-05	String 5	
		03-06	String 6	
		03-07	String 7	
		03-08	String 8	

If any problem, please contact with the supplier and provide following information:

- Model of the inverter: \_\_\_\_\_;
- Serial No. of the inverter: \_\_\_\_\_;
- System version:
  - version 1: \_\_\_\_\_;
  - version 2: \_\_\_\_\_;
  - MCU software version: \_\_\_\_\_;
- Fault code: \_\_\_\_\_;
- Fault description \_\_\_\_\_

## 8 Contact information

### China·Shenzhen

INVT Solar Technology (Shenzhen) Co., Ltd.

Address: 2nd Floor, Block B, Yingweiteng Guangming Technology Building, Songbai Road, Matian

Street, Guangming District, Shenzhen

Service Hotline: +86 400 700 9997

Email: [solar-service@invt.com.cn](mailto:solar-service@invt.com.cn)

INVT website: [www.invt.com](http://www.invt.com)

INVT Solar website: [www.invt-solar.com](http://www.invt-solar.com)

## 9 Appendix

Table 9-1 Technical parameters of single-phase PV grid-connected inverter

Technical specifications	XG3KTL-2M	XG4KTL	XG5KTL	XG6KTL	XG7KTL	XG7KTL1	XG8KTL	XG8KTL1	XG10KTL	XG10KTL1
DC side										
Maximum input power(W)	4500W	6000W	7500W	9000W	10500W	10500W	12000W	12000W	15000W	15000W
Maximum DC voltage	600V									
Starting voltage	80V									
MPPT voltage range	80V-580V									
Number of MPPT channels	2	2	2	2	2	2	2	2	2	2
Maximum number of strings per MPPT	1/1	1/1	1/1	1/1	1/1	1/2	1/1	1/2	1/1	1/2
Maximum input current per MPPT	20A/20A	20A/20A	20A/20A	20A/20A	20A/20A	28A/14A	20A/20A	28A/14A	20A/20A	28A/14A
Maximum short-circuit current of each MPPT	26A/26A	26A/26A	26A/26A	26A/26A	26A/26A	36.4A/18.2A	26A/26A	36.4A/18.2A	26A/26A	36.4A/18.2A
AC side										
Rated output power	3000W	4000W	5000W <sub>a</sub>	6000W	7000W	7000W	8000W	8000W	10000W	10000W
Rated output voltage	220Vac/230Vac/240Vac									
Rated output voltage frequency	50Hz/60Hz									
Maximum output current	15A	20A	25Ad	30A	35A	35A	40A	40A	45.5A	45.5A
Power factor	0.8 leading to 0.8 lagging									
Harmonic distortion	<3%(rated power)									
Efficiency										
Maximum efficiency	98.1%	98.3%	98.3%	98.3%	98.1%	98.1%	98.1%	98.1%	98.1%	98.1%
Chinese efficiency	97.3%	97.4%	97.4%	97.4%	97.3%	97.3%	97.3%	97.3%	97.3%	97.3%
Protection function										
DC switch	√									
islanding protection	√									
Output overcurrent protection	√									
DC reverse polarity protection	√									
String fault detection	√									
Insulation resistance detection	√									
AC short-circuit protection	√									
Arc fault protection	option									
System										
Dimensions (W×H×D)	380*380*160mm									
weight	≤13KG									
Operating temperature range	-30℃...+60℃									
Maximum allowable altitude	≤4000m									
Relative humidity	0-100%									
Protection rating	IP66									
Inverter topology	Transformer-less									
communication	RS485/WIFI/4G									
Display	LCD/LED/WIFI+APP									



Service Hotline: +86 400 700 9997 Email: [solar-service@invt.com.cn](mailto:solar-service@invt.com.cn) website: [www.invt-solar.com](http://www.invt-solar.com)

---

**INVT Solar Technology (Shenzhen) Co., Ltd.**  
**2nd Floor, Block B, Yingweiteng Guangming Technology Building, Songbai Road, Matian**